

ACROVYN® BED LOCATORS

Bed Locators are crucial to protect walls from damage at bed head locations. In addition, where there are medical equipment rails mounted on the bed head walls, bed locators can be fixed with stand-off brackets affording protection to the equipment rails, when the bed positions are altered.

The range offers vertical or horizontal orientations with differing stand-offs and includes an anti-ligature solution.



Bristol Royal Infirmary

BL100, BL100A, BL100M and BL100AM



BL100



BL100A

Features

- Acrovyn cover over continuous aluminium retainer
- Acrovyn End Cap options providing precise bed location (BL100, BL100M) or bed head rail protection (BL100A, BL100AM)
- BL100 and BL100A models are mounted on cushions
- BL100M and BL100AM are mounted on powder coated aluminium extended brackets (max 300mm stand off)
- For extra durability we recommend fixing bed locators to plywood pattresses or timber noggings
- Acrovyn cover and End Caps available in all Acrovyn Profile colours

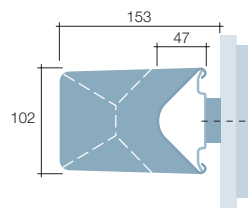

BL100

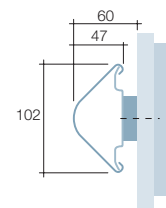

BL100A

Medium duty single bed locator for mounting in horizontal orientation



Dimensions

Length 1.1m standard (1.6m max.)
Fix at max. 400mm centres

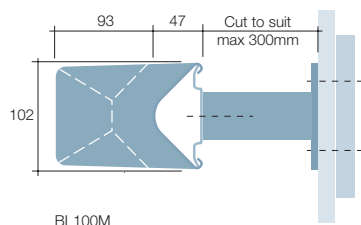

BL100M

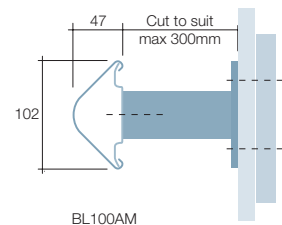

BL100AM

BL300 and BL300M

Medium duty bed locators for mounting in pairs in vertical orientation

**Dimensions**

Standard height 0.75m

Fix at max 400mm centres

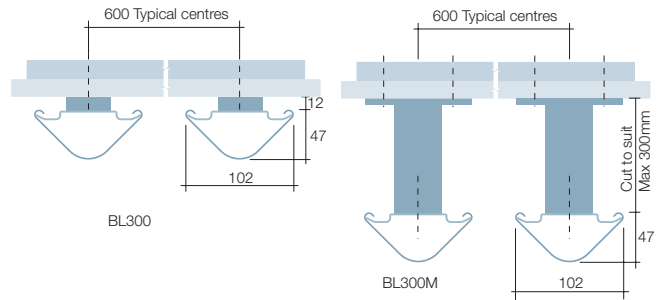
**Features**

- Acrovyn cover over continuous aluminium retainer complete with Acrovyn End Caps
- BL300 mounted on cushions
- BL300M mounted on powder coated aluminium extended brackets (max 300mm stand off)
- For extra durability we recommend fixing bed locators to plywood pattresses or timber noggings
- Acrovyn cover and End Caps available in all Acrovyn Profile colours

BL400(76) and BL400M

Severe duty bed locators for mounting in pairs in vertical orientation

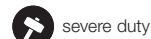
**Dimensions**

Standard height 0.75m

Fix at max 400mm centres

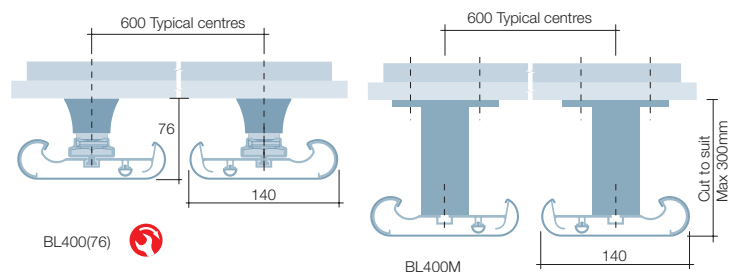
**Features**

- Acrovyn cover over continuous aluminium retainer complete with Acrovyn End Caps
- Shock absorbing bumper cushion for increased impact protection
- BL400(76) mounted on Rapid Fix Acrovyn brackets
- BL400M mounted on powder coated aluminium extended brackets (max 300mm stand off)
- Anti-ligature version BL400(AL) mounted on continuous brackets is also available
- For extra durability we recommend fixing bed locators to plywood pattresses or timber noggings
- Acrovyn cover and End Caps available in all Acrovyn Profile colours

BL500

Medium duty bed locators for mounting in pairs in vertical orientation

**Dimensions**

Standard height 0.75m

Fix at max 400mm centres

Features

- Acrovyn cover over continuous aluminium retainer
- Supplied with stainless steel End Caps and mounting brackets with covered base plate
- Infill strip to close off retainer groove provides a continuous 'easy clean' surface
- For extra durability we recommend fixing bed locators to plywood pattresses or timber noggings
- Acrovyn cover available in all Acrovyn Profile colours

